

LM741

Single Operational Amplifier

Features

- Short circuit protection
- Excellent temperature stability
- Internal frequency compensation
- High Input voltage range
- Null of offset

Description

The LM741 series are general purpose operational amplifiers. It is intended for a wide range of analog applications. The high gain and wide range of operating voltage provide superior performance in integrator, summing amplifier, and general feedback applications.

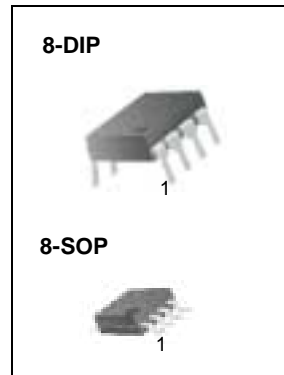

Internal Block Diagram

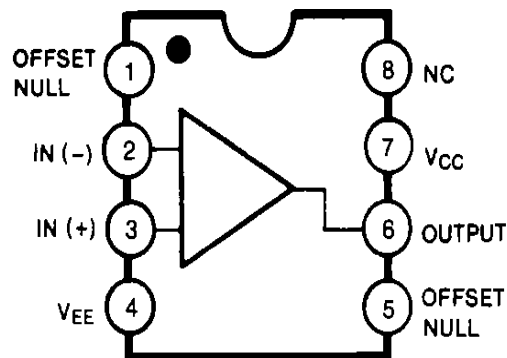

Schematic Diagram

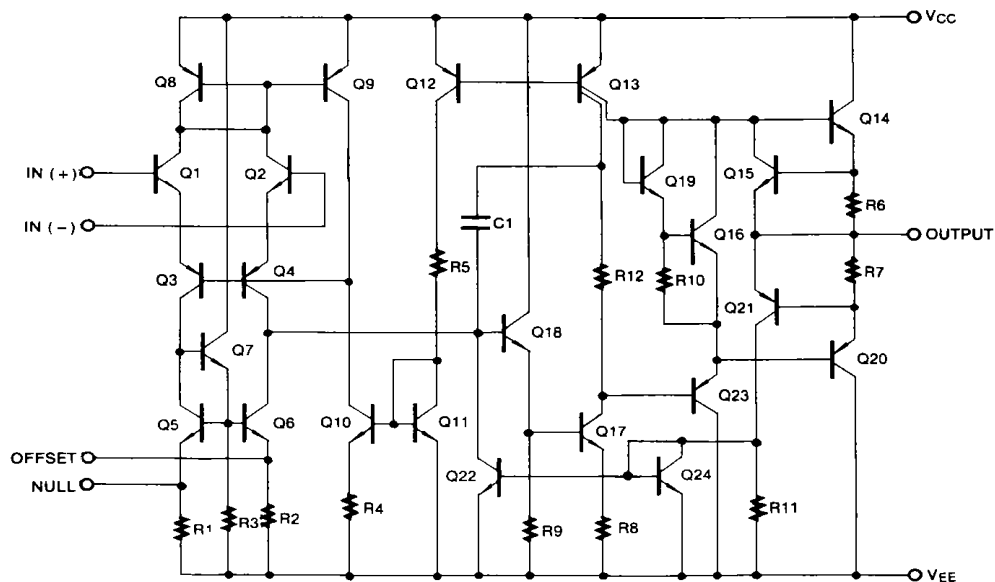

Absolute Maximum Ratings (TA = 25°C)

Parameter	Symbol	Value	Unit
Supply Voltage	VCC	±18	V
Differential Input Voltage	VI(DIFF)	30	V
Input Voltage	VI	±15	V
Output Short Circuit Duration	-	Indefinite	-
Power Dissipation	PD	500	mW
Operating Temperature Range LM741C LM741I	TOPR	0 ~ +70 -40 ~ +85	°C
Storage Temperature Range	TSTG	-65 ~ +150	°C

Electrical Characteristics

($V_{CC} = 15V$, $V_{EE} = -15V$. $T_A = 25^\circ C$, unless otherwise specified)

Parameter		Symbol	Conditions	LM741C/LM741I			Unit
				Min.	Typ.	Max.	
Input Offset Voltage	V_{IO}		$R_S \leq 10K\Omega$	-	2.0	6.0	mV
			$R_S \leq 50\Omega$	-	-	-	
Input Offset Voltage Adjustment Range	$V_{IO(R)}$		$V_{CC} = \pm 20V$	-	± 15	-	mV
Input Offset Current	I_{IO}		-	-	20	200	nA
Input Bias Current	I_{BIAS}		-	-	80	500	nA
Input Resistance (Note1)	R_I		$V_{CC} = \pm 20V$	0.3	2.0	-	$M\Omega$
Input Voltage Range	$V_{I(R)}$		-	± 12	± 13	-	V
Large Signal Voltage Gain	G_V	$R_L \geq 2K\Omega$	$V_{CC} = \pm 20V$, $V_{O(P-P)} = \pm 15V$	-	-	-	V/mV
			$V_{CC} = \pm 15V$, $V_{O(P-P)} = \pm 10V$	20	200	-	
Output Short Circuit Current	I_{SC}		-	-	25	-	mA
Output Voltage Swing	$V_{O(P-P)}$	$V_{CC} = \pm 20V$	$R_L \geq 10K\Omega$	-	-	-	V
			$R_L \geq 2K\Omega$	-	-	-	
		$V_{CC} = \pm 15V$	$R_L \geq 10K\Omega$	± 12	± 14	-	
			$R_L \geq 2K\Omega$	± 10	± 13	-	
Common Mode Rejection Ratio	CMRR	$R_S \leq 10K\Omega$, $V_{CM} = \pm 12V$	70	90	-	dB	
		$R_S \leq 50\Omega$, $V_{CM} = \pm 12V$	-	-	-		
Power Supply Rejection Ratio	PSRR	$V_{CC} = \pm 15V$ to $V_{CC} = \pm 15V$ $R_S \leq 50\Omega$	-	-	-	dB	
		$V_{CC} = \pm 15V$ to $V_{CC} = \pm 15V$ $R_S \leq 10K\Omega$	77	96	-		
Transient Response	Rise Time	T_R	Unity Gain	-	0.3	-	μs
	Overshoot	OS		-	10	-	%
Bandwidth		BW	-	-	-	MHz	
Slew Rate		SR	Unity Gain	-	0.5	-	$V/\mu s$
Supply Current		I_{CC}	$R_L = \infty\Omega$	-	1.5	2.8	mA
Power Consumption	P_C	$V_{CC} = \pm 20V$	-	-	-	mW	
		$V_{CC} = \pm 15V$	-	50	85		

Note:

1. Guaranteed by design.

Electrical Characteristics

($0^{\circ}\text{C} \leq T_A \leq 70^{\circ}\text{C}$ $V_{CC} = \pm 15\text{V}$, unless otherwise specified)

The following specification apply over the range of $0^{\circ}\text{C} \leq T_A \leq +70^{\circ}\text{C}$ for the LM741C; and the $-40^{\circ}\text{C} \leq T_A \leq +85^{\circ}\text{C}$ for the LM741I

Parameter	Symbol	Conditions	LM741C/LM741I			Unit	
			Min.	Typ.	Max.		
Input Offset Voltage	V_{IO}	$R_S \leq 50\Omega$	-	-	-	mV	
		$R_S \leq 10\text{K}\Omega$	-	-	7.5		
Input Offset Voltage Drift	$\Delta V_{IO}/\Delta T$	-	-	-	-	$\mu\text{V}/^{\circ}\text{C}$	
Input Offset Current	I_{IO}	-	-	-	300	nA	
Input Offset Current Drift	$\Delta I_{IO}/\Delta T$	-	-	-	-	$\text{nA}/^{\circ}\text{C}$	
Input Bias Current	I_{BIAS}	-	-	-	0.8	μA	
Input Resistance (Note1)	R_I	$V_{CC} = \pm 20\text{V}$	-	-	-	$\text{M}\Omega$	
Input Voltage Range	$V_{I(R)}$	-	± 12	± 13	-	V	
Output Voltage Swing	$V_{O(P-P)}$	$V_{CC} = \pm 20\text{V}$	$R_S \geq 10\text{K}\Omega$	-	-	-	V
			$R_S \geq 2\text{K}\Omega$	-	-	-	
		$V_{CC} = \pm 15\text{V}$	$R_S \geq 10\text{K}\Omega$	± 12	± 14	-	
			$R_S \geq 2\text{K}\Omega$	± 10	± 13	-	
Output Short Circuit Current	I_{SC}	-	10	-	40	mA	
Common Mode Rejection Ratio	CMRR	$R_S \leq 10\text{K}\Omega$, $V_{CM} = \pm 12\text{V}$	70	90	-	dB	
		$R_S \leq 50\Omega$, $V_{CM} = \pm 12\text{V}$	-	-	-		
Power Supply Rejection Ratio	PSRR	$V_{CC} = \pm 20\text{V}$ to $\pm 5\text{V}$	$R_S \leq 50\Omega$	-	-	-	dB
			$R_S \leq 10\text{K}\Omega$	77	96	-	
Large Signal Voltage Gain	G_V	$R_S \geq 2\text{K}\Omega$	$V_{CC} = \pm 20\text{V}$, $V_{O(P-P)} = \pm 15\text{V}$	-	-	-	V/mV
			$V_{CC} = \pm 15\text{V}$, $V_{O(P-P)} = \pm 10\text{V}$	15	-	-	
			$V_{CC} = \pm 15\text{V}$, $V_{O(P-P)} = \pm 2\text{V}$	-	-	-	

Note :

1. Guaranteed by design.

Typical Performance Characteristics

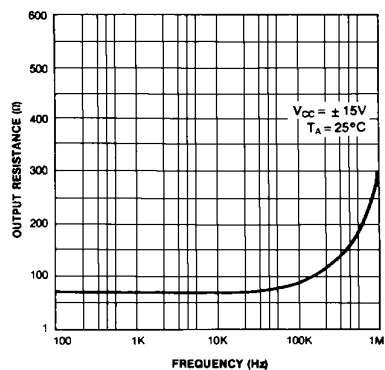

Figure 1. Output Resistance vs Frequency

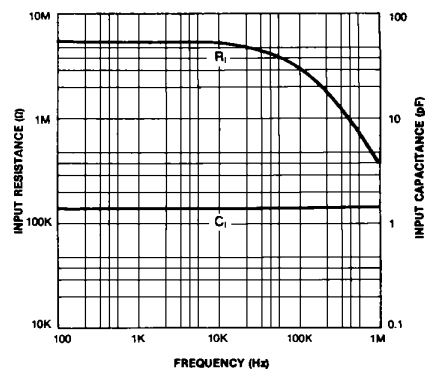

Figure 2. Input Resistance and Input Capacitance vs Frequency

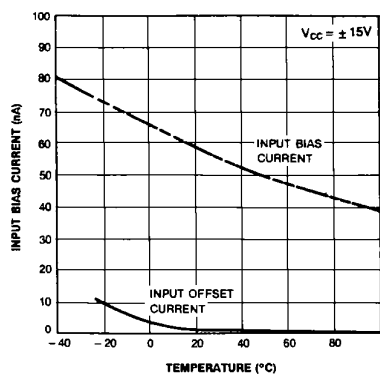

Figure 3. Input Bias Current vs Ambient Temperature

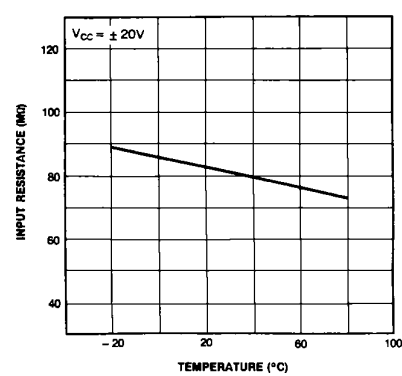

Figure 4. Power Consumption vs Ambient Temperature

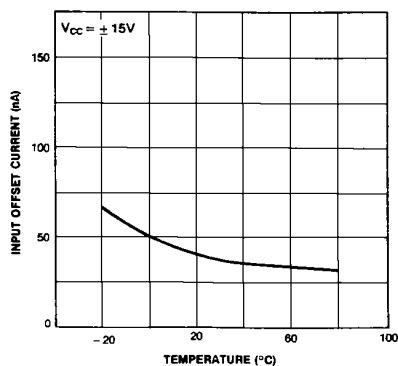

Figure 5. Input Offset Current vs Ambient Temperature

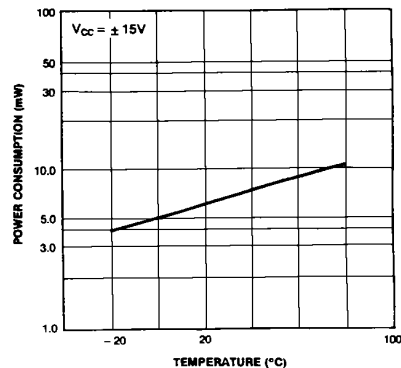

Figure 6. Input Resistance vs Ambient Temperature

Typical Performance Characteristics (continued)

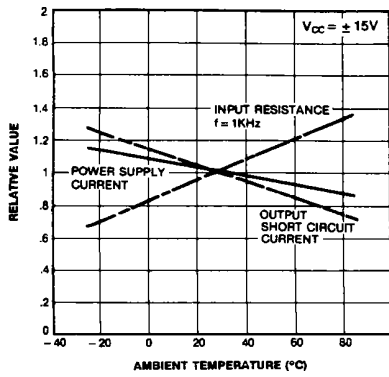

Figure 7. Normalized DC Parameters vs Ambient Temperature

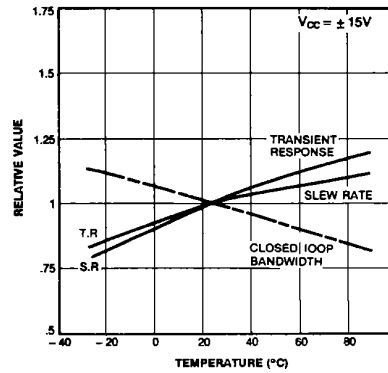

Figure 8. Frequency Characteristics vs Ambient Temperature

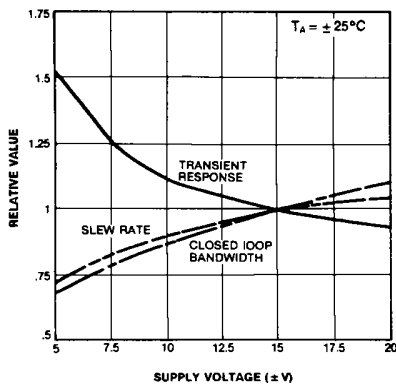

Figure 9. Frequency Characteristics vs Supply Voltage

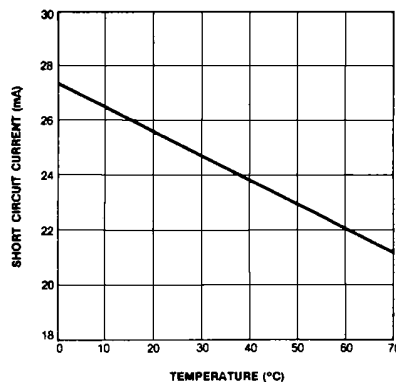

Figure 10. Output Short Circuit Current vs Ambient Temperature

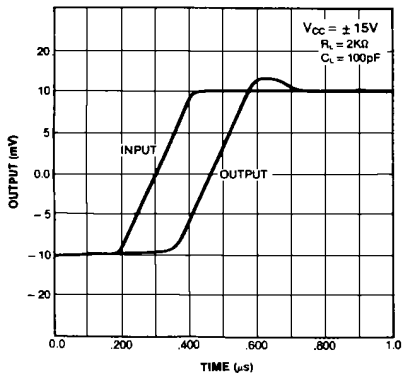

Figure 11. Transient Response

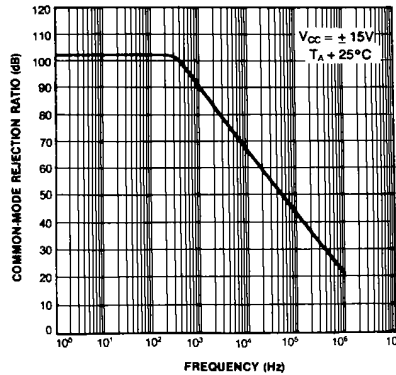

Figure 12. Common-Mode Rejection Ratio vs Frequency

Typical Performance Characteristics (continued)

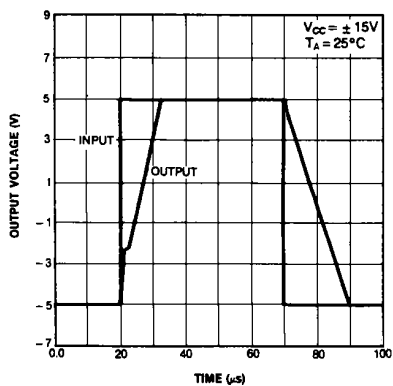

Figure 13. Voltage Follower Large Signal Pulse Response

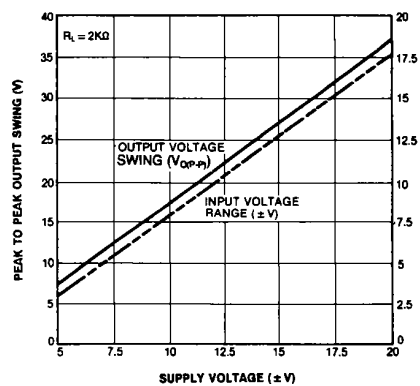
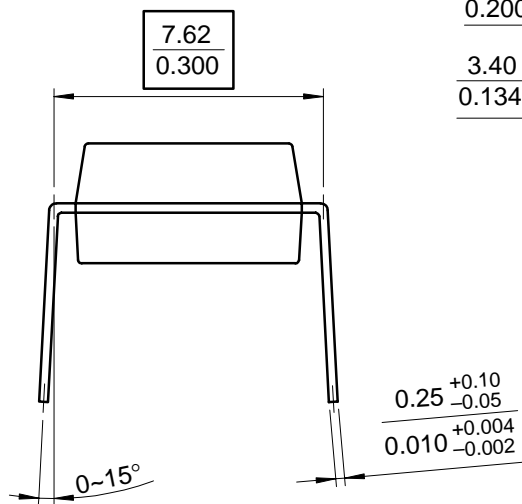
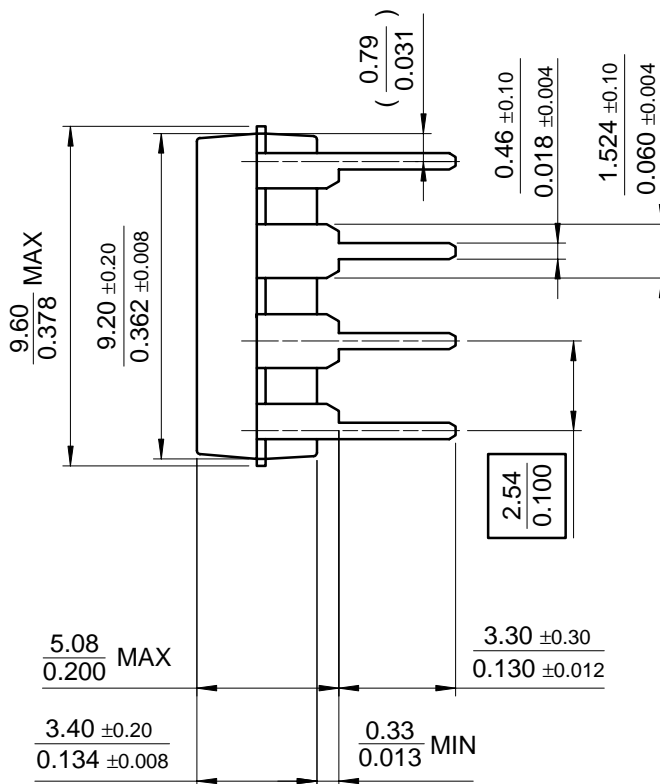
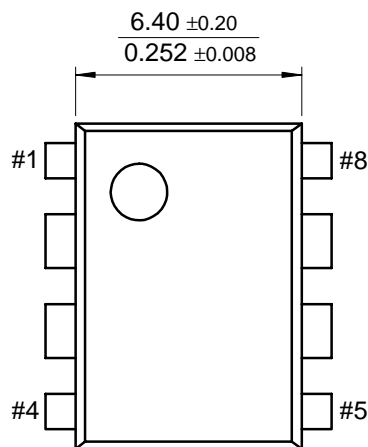

Figure 14. Output Swing and Input Range vs Supply Voltage

Mechanical Dimensions

Package

8-DIP



Mechanical Dimensions (Continued)

Package

8-SOP

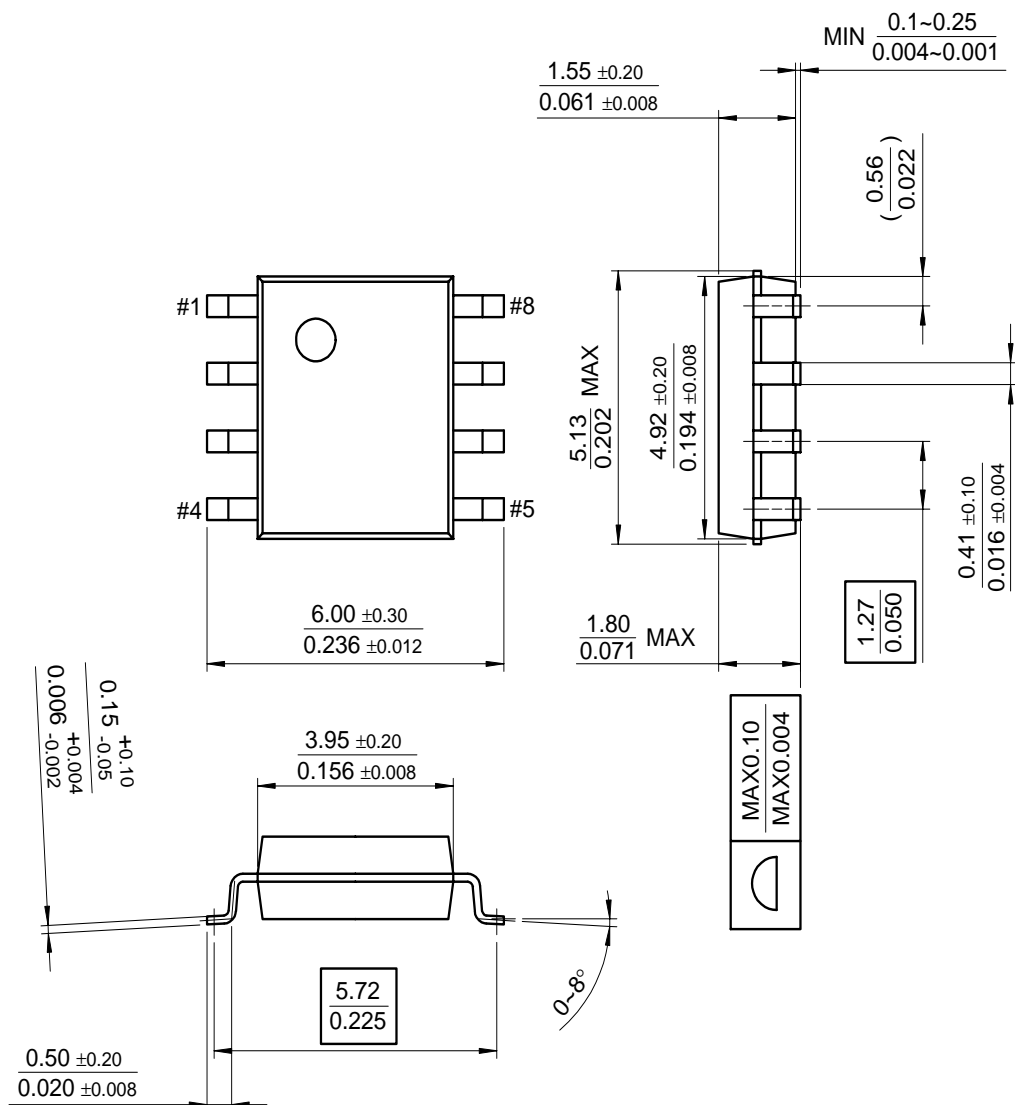

Ordering Information

Product Number	Package	Operating Temperature
LM741CN	8-DIP	0 ~ + 70°C
LM741CM	8-SOP	
LM741IN	8-DIP	-40 ~ + 85°C

DISCLAIMER

FAIRCHILD SEMICONDUCTOR RESERVES THE RIGHT TO MAKE CHANGES WITHOUT FURTHER NOTICE TO ANY PRODUCTS HEREIN TO IMPROVE RELIABILITY, FUNCTION OR DESIGN. FAIRCHILD DOES NOT ASSUME ANY LIABILITY ARISING OUT OF THE APPLICATION OR USE OF ANY PRODUCT OR CIRCUIT DESCRIBED HEREIN; NEITHER DOES IT CONVEY ANY LICENSE UNDER ITS PATENT RIGHTS, NOR THE RIGHTS OF OTHERS.

LIFE SUPPORT POLICY

FAIRCHILD'S PRODUCTS ARE NOT AUTHORIZED FOR USE AS CRITICAL COMPONENTS IN LIFE SUPPORT DEVICES OR SYSTEMS WITHOUT THE EXPRESS WRITTEN APPROVAL OF THE PRESIDENT OF FAIRCHILD SEMICONDUCTOR CORPORATION. As used herein:

1. Life support devices or systems are devices or systems which, (a) are intended for surgical implant into the body, or (b) support or sustain life, and (c) whose failure to perform when properly used in accordance with instructions for use provided in the labeling, can be reasonably expected to result in a significant injury of the user.
2. A critical component in any component of a life support device or system whose failure to perform can be reasonably expected to cause the failure of the life support device or system, or to affect its safety or effectiveness.